

MDSTB 2,5/10-G1

Order No.: 1762774

The figure shows a 10-position version of the product

<http://eshop.phoenixcontact.de/phoenix/treeViewClick.do?UID=1762774>Header, nominal current: 10 A, rated voltage: 250 V, pitch: 5.0 mm, no.
of positions: 10, mounting: Soldering

Commercial data

EAN	4017918031350
Pack	50 Pcs.
Customs tariff	85366990
Weight/Piece	0.01808 KG
Catalog page information	Page 229 (CC-2007)

Product notes

WEEE/RoHS-compliant since:
01/01/2003

<http://www.download.phoenixcontact.com>
Please note that the data given here has been taken from the online catalog. For comprehensive information and data, please refer to the user documentation. The General Terms and Conditions of Use apply to Internet downloads.

Technical data

Dimensions / positions

Pitch	5 mm
Dimension a	45 mm
Number of positions	10
Pin dimensions	1 x 1 mm
Hole diameter	1.4 mm

Technical data

Insulating material group	I
Rated surge voltage (III/3)	4 kV
Rated surge voltage (III/2)	4 kV
Rated surge voltage (II/2)	4 kV
Rated voltage (III/2)	320 V
Rated voltage (II/2)	630 V
Connection in acc. with standard	EN-VDE
Nominal current I_N	10 A
Nominal voltage U_N	250 V
Maximum load current	10 A
Insulating material	PA
Inflammability class acc. to UL 94	V0

Certificates / Approvals



CSA

Nominal voltage U_N	300 V
Nominal current I_N	10 A

CUL

Nominal voltage U_N	300 V
Nominal current I_N	10 A

UL

Nominal voltage U_N	300 V
Nominal current I_N	10 A
Certification	CB, CSA, CUL, GOST, UL, VDE-PZI

Accessories

Item	Designation	Description
------	-------------	-------------

Assembly

1755477	MSTB-BL	Keying cap, for forming sections, plugs onto header pin, green insulating material
---------	---------	--

Marking

0804183	SK 5/3,8:FORTL.ZAHLEN	Marker card, printed horizontally, self-adhesive, 12 identical decades marked 1-10, 11-20 etc. up to 91-(99)100, sufficient for 120 terminal blocks
---------	-----------------------	---

Plug/Adapter

1734401	CR-MSTB	Coding section, inserted into the recess in the header or the inverted plug, red insulating material
---------	---------	--

Additional products

Item	Designation	Description
------	-------------	-------------

Assembly

1909294	FKCT 2,5/10-ST	Plug component, nominal current: 12 A, rated voltage: 250 V, pitch: 5.0 mm, no. of positions: 10, type of connection: Spring-cage connection
---------	----------------	--

General

1910432	FKC 2,5/10-ST	Plug component, nominal current: 12 A, rated voltage: 250 V, pitch: 5.0 mm, no. of positions: 10, type of connection: Spring-cage connection
1909799	FKCVR 2,5/10-ST	Plug component, nominal current: 12 A, rated voltage: 250 V, pitch: 5.0 mm, no. of positions: 10, type of connection: Spring-cage connection
1910115	FKCVW 2,5/10-ST	Plug component, nominal current: 12 A, rated voltage: 250 V, pitch: 5.0 mm, no. of positions: 10, type of connection: Spring-cage connection
1779495	FRONT-MSTB 2,5/10-ST	Plug component, nominal current: 12 A, rated voltage: 250 V, pitch: 5.0 mm, no. of positions: 10, type of connection: Screw connection
1754601	MSTB 2,5/10-ST	Plug component, nominal current: 12 A, rated voltage: 250 V, pitch: 5.0 mm, no. of positions: 10, type of connection: Screw connection
1759004	MSTB 2,5/10-STZ	Plug component, nominal current: 12 A, rated voltage: 250 V, pitch: 5.0 mm, no. of positions: 10, type of connection: Screw connection
1765852	MSTBP 2,5/10-ST	Plug component, nominal current: 12 A, rated voltage: 250 V, pitch: 5.0 mm, no. of positions: 10, type of connection: Screw connection
1779916	MSTBT 2,5/10-ST	Plug component, nominal current: 12 A, rated voltage: 250 V, pitch: 5.0 mm, no. of positions: 10, type of connection: Screw connection
1792090	MVSTBR 2,5/10-ST	Plug component, nominal current: 12 A, rated voltage: 250 V, pitch: 5.0 mm, no. of positions: 10, type of connection: Screw connection

1792605	MVSTBW 2,5/10-ST	Plug component, nominal current: 12 A, rated voltage: 250 V, pitch: 5.0 mm, no. of positions: 10, type of connection: Screw connection
1768833	SMSTB 2,5/10-ST	Plug component, nominal current: 12 A, rated voltage: 250 V, pitch: 5.0 mm, no. of positions: 10, type of connection: Screw connection

Drawings

Drilling diagram

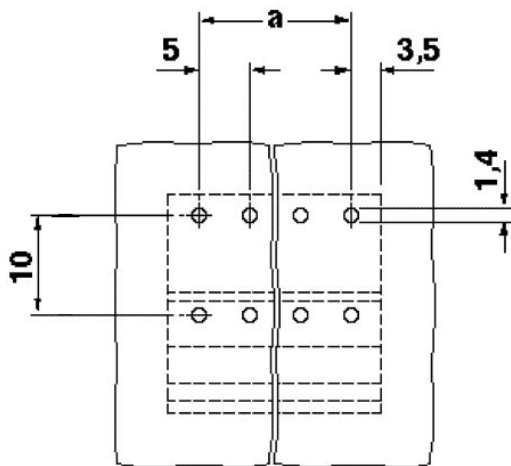

Dimensioned drawing

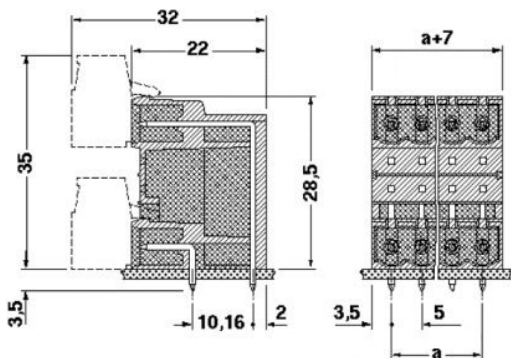

Address

PHOENIX CONTACT GmbH & Co. KG
Flachsmarktstr. 8
32825 Blomberg, Germany
Phone +49 5235 3 00
Fax +49 5235 3 41200
<http://www.phoenixcontact.de>



© 2008 Phoenix Contact
Technical modifications reserved;